

Proximity sensors SMT/SME-10, for C-slot



Proximity sensors SMT/SME

Product range overview

Design	Type of mounting	Measuring principle	Type	Operating voltage range	Switching output	Switching element function	→ Page/ Internet
For C-slot	Standard						
	Insertable in slot from above, flush with cylinder profile	Magneto-resistive	SMT-10M	10 ... 30 V DC	PNP	N/O contact	7
					NPN		
	Insertable in slot length-wise	Magnetic reed	SME-10M	5 ... 30 V AC/DC	Contacting, bipolar	N/O contact	12
		Magneto-resistive	SMT-10G	10 ... 30 V DC	PNP	N/O contact	21
Magnetic reed		SME-10	12 ... 27 V AC/DC	Contacting	N/O contact	18	
For T-slot	Standard						
	Insertable in slot from above, flush with cylinder profile	Magneto-resistive	SMT-8M	10 ... 30 V DC	PNP	N/O contact	t-slot
					NPN	N/C contact	
		Magnetic reed	SME-8M	5 ... 30 V AC/DC	Contacting, bipolar	N/O contact	
						N/C contact	
	Insertable in slot length-wise, flush with cylinder profile	Magneto-resistive	SMT-8	10 ... 30 V DC	PNP	N/O contact	
					NPN		
	Insertable in slot length-wise, flush with cylinder profile	Magnetic reed	SME-8	12 ... 30 V AC/DC	Contacting, bipolar	N/O contact	
				3 ... 230 V AC/DC		N/C contact	
				5 ... 250 V AC/DC		N/O contact	
	Insertable in slot length-wise	Magneto-resistive	SMT-8G	10 ... 30 V DC	PNP	N/O contact	
		Magneto-resistive	SMT-8-SL	10 ... 30 V DC	PNP	N/O contact	
		Magnetic reed	SME-8-SL	10 ... 30 V AC/DC	Contacting, bipolar	N/O contact	
	Insertable in slot from above	Magnetic reed	SME-8-FM	10 ... 30 V AC/DC	Contacting, bipolar	N/O contact	
	Via accessories	Magneto-resistive	SMT0-8E	10 ... 30 V DC	PNP	N/O contact	
					NPN		
		Magnetic reed	SME0-8E	12 ... 30 V DC	Contacting, bipolar	N/O contact	
				3 ... 250 V DC			
				3 ... 230 V AC			
	Corrosion resistant						
	Insertable in slot length-wise, flush with cylinder profile	Magneto-resistive	CRSMT-8	10 ... 30 V DC	PNP	N/O contact	t-slot
	Welding field immune						
Via accessories	Magneto-inductive	SMTSO-8E	10 ... 30 V DC	PNP	N/O contact	t-slot	
				NPN			
Heat resistant up to 120 °C							
Insertable in slot length-wise, flush with cylinder profile	Magnetic reed	SME-8-...-S6	0 ... 30 V AC/DC	Contacting, bipolar	N/O contact	t-slot	
Via accessories	Magnetic reed	SME0-8E-...-S6	0 ... 30 V DC	Contacting	N/O contact	t-slot	
			0 ... 30 V AC				

Proximity sensors SMT/SME

Selection aid

Drive	SMT-8, SMT0-8E CRSMT-8 SME-8, SME0-8E SMPO-8E	SMT-10 SME-10	SMT0-4U SME0-4U CRSME0-4	SMT0-1 SMT0-6 SME0-1 SMPO-1	SMT-C1
Standards-based cylinders					
Standard cylinders DSNU, ESNU	∅ 8 ... 25 mm	■	■	■	-
Standard cylinders DSN, ESN	∅ 8 ... 25 mm	■	■	■	-
Standard cylinders DNCB		■	-	-	-
Standard cylinders DNC		■	-	-	-
Standard cylinders DNG		■	-	■	-
Standard cylinders CDN-...-R with sensor rail		-	-	-	■
Standard cylinders ADN		■	-	-	-
Cylinders with piston rod					
Compact cylinders ADVU, AEVU		■	-	-	-
Short-stroke cylinders ADVC, AEVC	∅ 6 ... 25 mm	-	■	-	-
	∅ 32 ... 100 mm	■	-	-	-
Flat cylinders EZH-10/40-40-A-B		■	-	-	-
Flat cylinders DZF		■	-	-	-
Flat cylinders DZH	∅ 16 ... 25 mm	■	-	-	-
	∅ 32 ... 63 mm	-	-	■	-
Round cylinders DSNU, ESNU	∅ 32 ... 63 mm	■	■	■	-
Round cylinders DSW, ESW		■	■	■	-
Round cylinders DSEU, ESEU		■	■	■	-
Multimount cylinders DMM, EMM		■	-	-	-
Round cylinders CRDG		-	-	■	-
Round cylinders CRDSW		■	■	■	-
Standard cylinders CRHD		■	-	-	-
Standard cylinders CRDSNU		■	-	■	-
Standard cylinders CRDNG		■	-	■	-
Standard cylinders CRDNGS		■	-	■	-
Rodless cylinders					
Linear drives DGC	∅ 8, 12 mm	-	■	-	-
	∅ 18 ... 63 mm	■	-	-	-
Linear drives DGP, DGPL		■	-	-	-
Linear drives SLG		-	■	-	-
Linear drives DGO		-	-	■	-
Linear drives SLM		■	-	-	-
Semi-rotary drives					
Semi-rotary drives DSM	∅ 6 ... 10 mm	-	■	-	-
Semi-rotary drives DSM-B	∅ 12 ... 40 mm	-	■	-	-
	∅ 63 mm	■	-	-	-
Semi-rotary drives DRQ	∅ 16 ... 32 mm	■	-	-	-
	∅ 40 ... 100 mm	-	-	■	-
Semi-rotary drives DRQD	∅ 6 ... 12 mm	-	■	-	-
	∅ 16 ... 32 mm	■	-	-	-
Technical data → Page/Internet	t-slot	7	smt0, crsmeo	smt0	smt-c1

Proximity sensors SMT/SME

FESTO

Selection aid

Drive	SMT-8, SMTO-8E CRSMT-8 SME-8, SME0-8E, SMPO-8E	SMT-10 SME-10	SMH-S1
Function-oriented drives			
Stopper cylinders STA, STAF	■	-	-
Linear/swivel clamps CLR	■	-	-
Swivel/linear units DSL	■	-	-
Swivel/linear units DSL-B	-	■	-
Drives with linear guide			
Mini slides SLS, SLF, SLT	-	■	-
Mini slides DGSL	-	■	-
Twin-piston cylinders SPZ	■	-	-
Slide units SLZ	■	-	-
Guided drives DFP	∅ 6 ... 16 mm	-	■
	∅ 25 ... 80 mm	■	-
Mini guide units DFC	-	■	-
Guide units DFM	■	-	-
Guide units DFM-B	■ ¹⁾	-	-
Linear drive units SLE	∅ 32 ... 50 mm	■	-
Twin-piston cylinders DPZ	■	-	-
Handling units			
Linear modules HMP	■	-	-
Linear modules HMPL	■	-	-
Handling modules HSP, HSW	■	-	-
Feed separators HPV	■	-	-
Three-point grippers HGD	∅ 16 mm	-	■
	∅ 32, 50 mm	■ ²⁾	-
Three-point grippers HGDT	-	■	-
Parallel grippers HGP	∅ 6 mm	-	■
	∅ 10 ... 35 mm	■ ²⁾	-
Parallel grippers HGPC	-	■	-
Parallel grippers HGPP	∅ 12 ... 32 mm	-	■
Parallel grippers HGPT	∅ 16 ... 63 mm	-	■
Angle grippers HGW	∅ 10 mm	-	■
	∅ 16 ... 40 mm	■	-
Radial grippers HGR	∅ 10 mm	-	■
	∅ 16 ... 40 mm	■	-
Swivel gripper units HGDS	-	■	-
Cushioning components			
Stop elements YSRWJ	■	-	-
Electrical positioning systems			
Toothed belt axes DGE-ZR	■	-	-
Spindle axes DGE-SP	■	-	-
System components			
Heavy-duty guides HD	■	-	-
Valve actuators			
Linear actuators, Copac DLP-A	■	-	-
Technical data → Page/Internet	t-slot	7	smh

1) Not SM...O-8E.

2) SME-8M only for HGD-50, HGP-20 ... 35.

Proximity sensors SMT/SME-10, for C-slot

Overview of peripherals

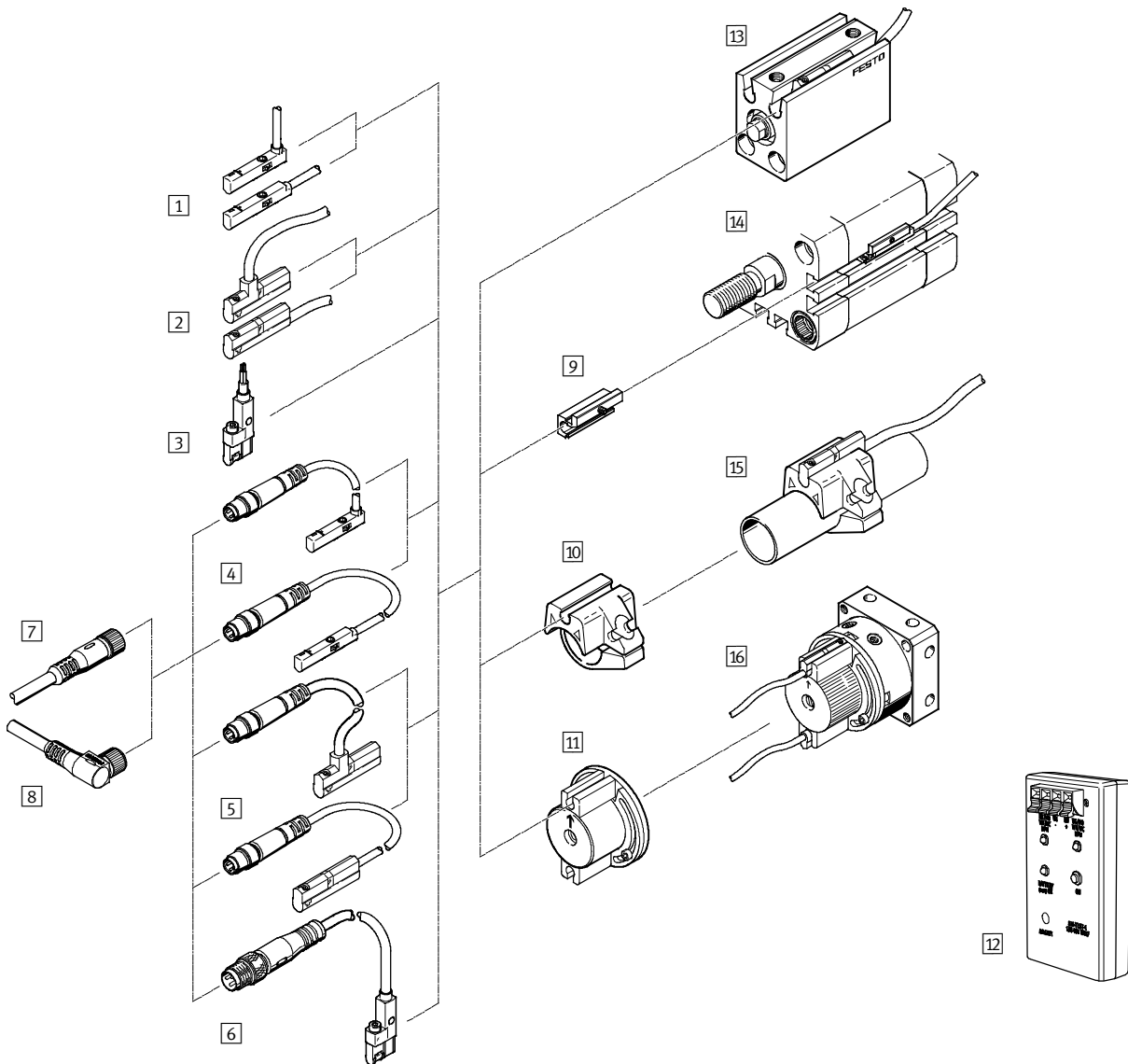

Mounting attachments and accessories	→ Page/ Internet
Proximity sensors	
1 SMT/SME-10M-...-OE, with cable	7
2 SME-10, with cable	18
3 SMT-10G-...-OE, with cable	22
4 SMT/SME-10M-...-M..., with cable and plug	7
5 SME-10, with cable and plug	18
6 SMT-10G-...-M..., with cable and plug	22
Connecting cables	
7 Connecting cable NEBU-M...G...	25
8 Connecting cable NEBU-M...W...	25
Mounting kits	
9 Mounting kit SMBN-10	24
10 Mounting kit SMBR-10-...	24
11 Mounting kit WSM-...-SME-10	25

Mounting attachments and accessories	→ Page/ Internet
Accessories	
12 Sensor tester SM-TEST-1	25
- Positioning component SMM-10	25
- Clip SMBK-10	25
- Inscription label ASLR	25
- Safety clip NEAU	25
Drives	
13 Drives with C-slot	-
14 Drives with T-slot	-
15 Round cylinder	-
16 Semi-rotary drive DSM	-

Proximity sensors SMT/SME-10M, for C-slot

Type codes

SMT/SME-10M

SMT - 10M - PS - 24V - E - 2,5 - L - - OE

Function	
SMT	Proximity sensor, magneto-resistive
SME	Proximity sensor, magnetic reed

Design	
10M	For C-slot, insertable in slot from above

Switching output, switching element function	
PS	PNP, N/O contact, 3-wire
NS	NPN, N/O contact, 3-wire
ZS	N/O contact, 2-wire
DS	N/O contact, 3-wire

Rated operating voltage	
24V	24 V DC

Cable attribute	
E	Energy chain + robot applications

Cable length [m]	

Cable outlet	
L	In-line
Q	Lateral

Cable designation	
-	With inscription label holder
N	Without inscription label holder

Connection technology	
OE	Open end
M8	Cable with plug M8x1, snap-on flange
M8D	Cable with plug M8x1, rotatable thread
M12	Cable with plug M12x1, rotatable thread

Proximity sensors SMT-10M, for C-slot

Technical data – Magneto-resistive

Function

E.g. PNP, N/O contact, with cable

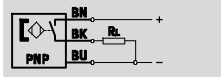

E.g. NPN, N/O contact, with cable

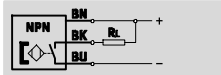

- Magneto-resistive measuring principle
- Insertable in slot from above, does not protrude over the cylinder profile
- Cable clip and holder for inscription labels included in the scope of delivery

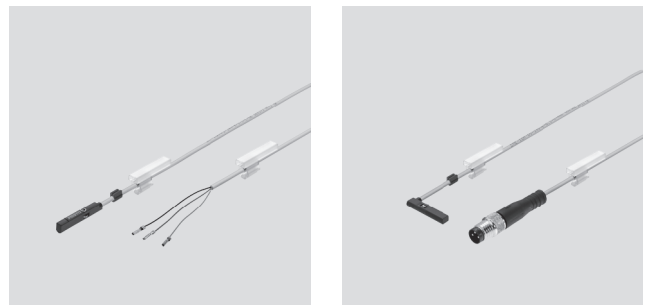

General technical data	
Design	For C-slot
Conforms to	EN 60947-5-2
Certification	C-Tick
CE mark (see declaration of conformity)	To EU EMC Directive ¹⁾
Note on materials	Cable resistant to oil
	Cable free of halogen
	Free of copper and PTFE
	RoHS-compliant

1) For information about the applicability of the component see the manufacturer's EC declaration of conformity at: www.festo.com → Support → User documentation.
If the component is subject to restrictions on usage in residential, office or commercial environments or small businesses, further measures to reduce the emitted interference may be necessary.

Input signal/measuring element	
Measured variable	Position
Measuring principle	Magneto-resistive
Ambient temperature	[°C] -20 ... +70

Switching output				
Type SMT-10M		PS	NS	ZS
Switching output		PNP	NPN	Non-contacting, 2-wire
Switching element function		N/O contact		
Repetition accuracy of switching output in ± mm	[mm]	0.1		
Switch-on time	[ms]	0 ... 1		
Switch-off time	[ms]	0 ... 1		
Max. switching frequency	[Hz]	150		
Max. output current	[mA]	100		
Max. output current in mounting kits	[mA]	50		
Max. switching capacity DC	[W]	3	3	2.4
Max. switching capacity DC in mounting kits	[W]	1.5		1.2
Voltage drop	[V]	0 ... 1.7	0 ... 1.5	0 ... 6

Output, additional data	
Protection against short circuit	Pulsed
Protection against overloading	Yes

Electronic components	
Rated operating voltage	[V DC] 24
Operating voltage range	[V DC] 10 ... 30
Reverse polarity protection	For all electrical connections

Proximity sensors SMT-10M, for C-slot

Technical data – Magneto-resistive

Electromechanical components								
Type SMT-10M	PS/NS				ZS			
Electrical connection	OE	M8D	M8	M12	OE	M8D	M8	M12
Electrical connection	Cable, 3-wire	Cable with plug, 3-pin			Cable, 2-wire	Cable with plug, 2-pin		
		M8x1	M8x1	M12x1		M8x1	M8x1	M12x1
		Rotatable thread	Snap-on flange	Rotatable thread		Rotatable thread	Snap-on flange	Rotatable thread
Connection direction	In-line Lateral							
Cable test conditions	Energy chain: 5 million cycles, bending radius 28 mm							
	Torsional strength: >300,000 cycles, ±270°/0.1 m							
	Resistance to bending: to Festo standard; test conditions on request							
Cable length [m]	0.2 ... 30							
Cable attribute	Energy chain + robot applications							
Cable sheath materials	TPE-U(PU)							

Mechanical components	
Type of mounting	Screw-clamped in slot, insertable from above
Max. tightening torque [Nm]	0.4
Mounting position	Any
Housing	PA reinforced
	High-alloy stainless steel

Display/operation	
Switching status display	Yellow LED

Immissions/emissions	
Ambient temperature with flexible cable installation [°C]	-20 ... +70
Protection class	IP65
	IP68

Pin allocation to EN 60947-5-2			
M8x1, 2-pin		M8x1, 3-pin	
N/O contact		N/O contact	
	Pin	Wire colour	Allocation
	1	Brown	+
	4	Black	Output
	1	Brown	+
	3	Blue	-
	4	Black	Output

Pin allocation to EN 60947-5-2			
M12x1, 2-pin		M12x1, 3-pin	
N/O contact		N/O contact	
	Pin	Wire colour	Allocation
	1	Brown	+
	4	Black	Output
	1	Brown	+
	3	Blue	-
	4	Black	Output

Proximity sensors SMT-10M, for C-slot

Technical data – Magneto-resistive

Dimensions

Download CAD data → www.festo.com

SMT-10M-...-L, in-line connection

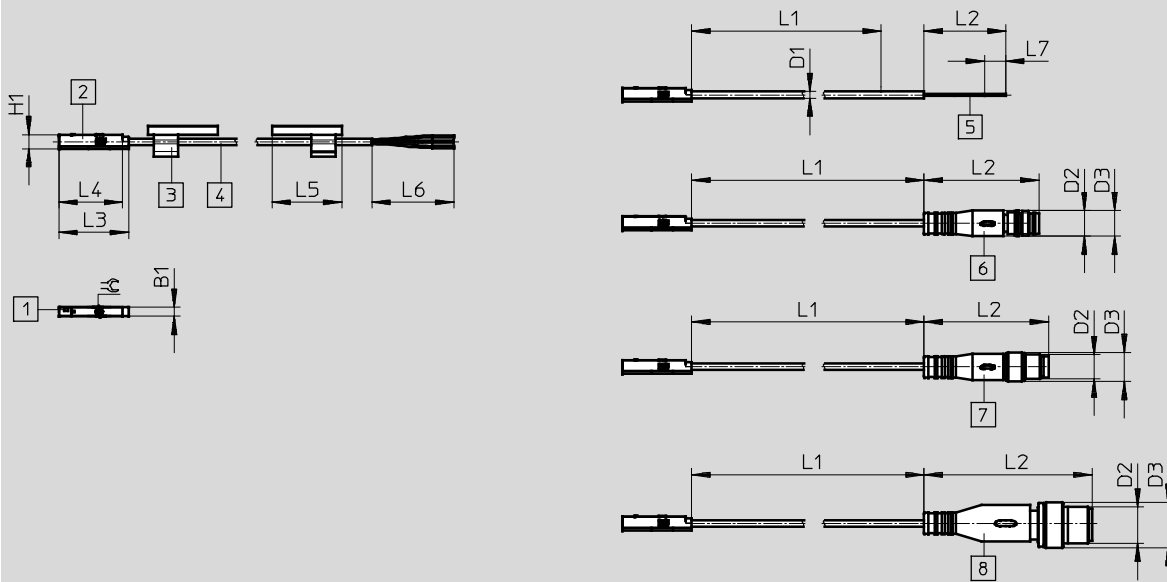

- 1 Yellow LED
- 2 SMT-10M
- 3 Inscription label holder
- 4 Connecting cable
- 5 Cable with open end
- 6 Plug M8x1, snap-on flange
- 7 Plug M8x1, rotatable thread
- 8 Plug M12x1
- L1 Cable length

Type	B1	D1	D2	D3	H1	L2	L3	L4	L5	L6	L7	⌀
SMT-10M-...-OE	2.9	2.15	-	-	4.6	50	22.9	20.9	23	50	7	1.5
SMT-10M-...-M8D			M8x1	8.5		32.7					-	
SMT-10M-...-M8			M8x1	9.6		41.1					-	
SMT-10M-...-M12			M12x1	15		55.5					-	

Proximity sensors SMT-10M, for C-slot

Technical data – Magneto-resistive

Dimensions

Download CAD data → www.festo.com

SMT-10M-...-Q, lateral connection

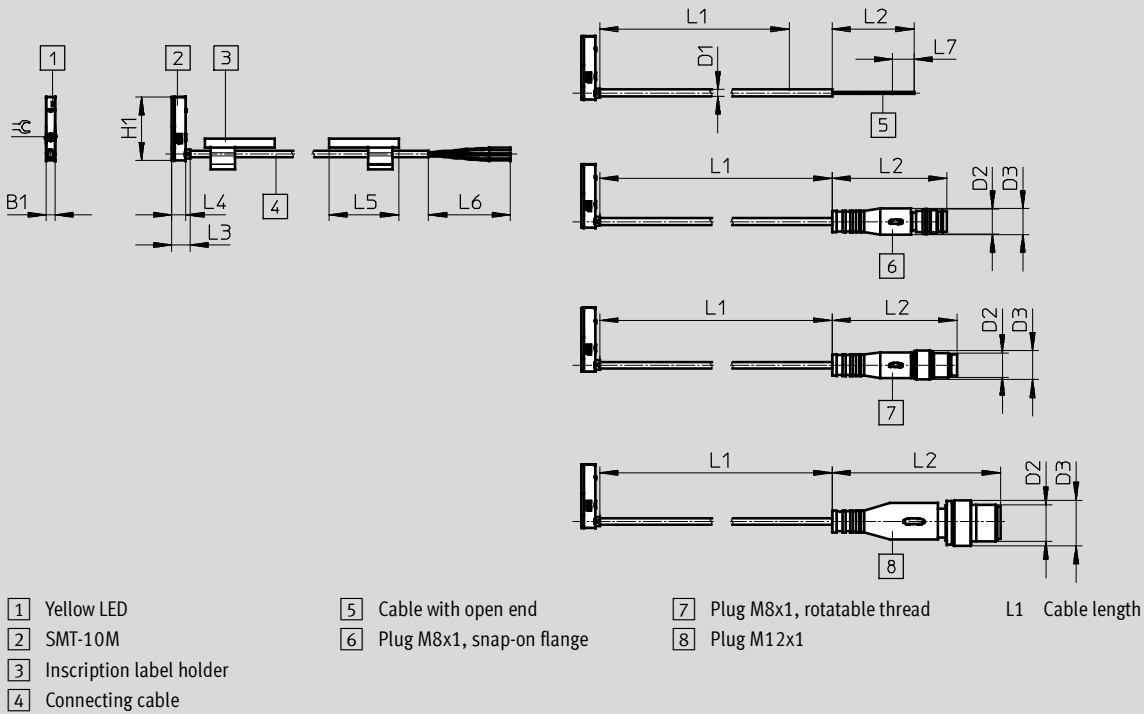

Type	B1	D1	D2	D3	H1	L2	L3	L4	L5	L6	L7	⊘
SMT-10M-...-OE	2.9	2.15	-	-	20.9	50	6	4.6	23	50	7	1.5
SMT-10M-...-M8D			M8x1	8.5		32.7					-	
SMT-10M-...-M8			M8x1	9.6		41.1					-	
SMT-10M-...-M12			M12x1	15		55.5					-	

	Switching output	Electrical connection		Cable length [m]	Weight [g]	Part No.	Type
		Cable	Cable with plug, rotatable thread				
	N/O contact						
	PNP	3-wire	-	2.5	16.8	551373	SMT-10M-PS-24V-E-2,5-L-OE
			M8x1, 3-pin	0.3	6.7	551374	SMT-10M-PS-24V-E-2,5-Q-OE
		-	-	-	-	-	551375
	NPN	3-wire	-	2.5	16.8	551377	SMT-10M-NS-24V-E-2,5-L-OE
			M8x1, 3-pin	0.3	6.7	551378	SMT-10M-NS-24V-E-2,5-Q-OE
		-	-	-	-	-	551379
	Non-contacting, 2-wire	2-wire	-	2.5	14.6	551382	SMT-10M-ZS-24V-E-2,5-L-OE
-			-	-	-	-	551383

Proximity sensors SMT-10M, for C-slot

Modular product system – Magneto-resistive

M Mandatory data						O Options	M	
Module No.	Function	Switching output	Rated operating voltage	Cable attribute	Cable length in m	Cable outlet	Cable designation	Connection technology
551372	SMT-10M	PS NS ZS	24V	E	0.2 ... 30	L Q	N	OE M8D M8 M12
Ordering example								
551372	SMT-10M	NS	24V	E	3	L	N	M8D

Ordering table				
Size	10	Conditions	Code	Enter code
M	Module No.	551372		
	Function	Proximity sensor for C-slot, non-contacting	SMT-10M	SMT-10M
	Switching output	3-wire PNP N/O contact	PS	-
		3-wire NPN N/O contact	NS	
		2-wire N/O contact	ZS	
			-	-
	Rated operating voltage [V DC]	24	24V	24V
			-	-
	Cable attribute	Energy chain + robot applications	E	E
			-	-
	Cable length [m]	0.2 ... 30 (0.2 ... 5.0 m in 0.1 m increments, 5.0 ... 30 m in 0.5 m increments)	...	
			-	-
	Cable outlet	In-line	L	
		Lateral	Q	
			-	-
O	Cable designation	With inscription label holder	-	
		Without inscription label holder	N	
			-	-
M	Connection technology	Open end	OE	
		M8, rotatable thread	M8D	
		M8, snap-on flange	M8	
		M12, rotatable thread	M12	

Transfer order code

551372	SMT-10M	-		-	24V	-	E	-		-		-		-	
--------	---------	---	--	---	-----	---	---	---	--	---	--	---	--	---	--

Proximity sensors SME-10M, for C-slot

Technical data – Magnetic reed



Function

E.g. N/O contact, 3-wire, with cable

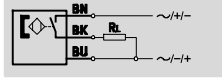

E.g. N/O contact, 3-wire, with plug

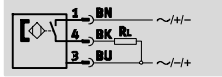

- Magnetic reed measuring principle
- Insertable in slot from above, does not protrude over the cylinder profile
- Cable clip and holder for inscription labels included in the scope of delivery

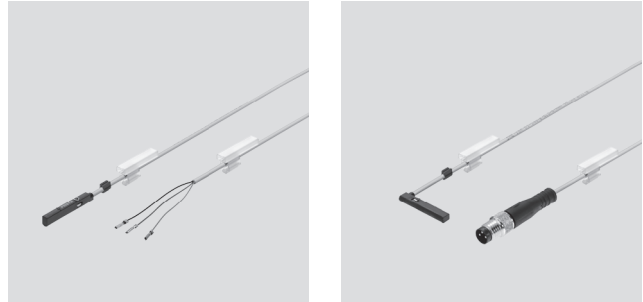

General technical data	
Design	For C-slot
Conforms to	EN 60947-5-2
Certification	C-Tick
CE mark (see declaration of conformity)	To EU EMC Directive ¹⁾
Note on materials	Cable resistant to oil
	Cable free of halogen
	Free of copper and PTFE
	RoHS-compliant

1) For information about the applicability of the component see the manufacturer's EC declaration of conformity at: www.festo.com → Support → User documentation.
If the component is subject to restrictions on usage in residential, office or commercial environments or small businesses, further measures to reduce the emitted interference may be necessary.

Input signal/measuring element	
Measured variable	Position
Measuring principle	Magnetic reed
Ambient temperature	[°C] -40 ... +70

Switching output		
Type SME-10M	DS	ZS
Switching output	Contacting, bipolar	
Switching element function	N/O contact	
Repetition accuracy of switching output in ± mm	0.1	
Switch-on time	[ms] 0 ... 1.2	
Switch-off time	[ms] 0 ... 1	
Max. switching frequency	[Hz] 50	
Max. output current	[mA] 300	100
Max. output current in mounting kits	[mA] 50	50
Max. switching capacity AC	[VA] 9	3
Max. switching capacity AC in mounting kits	[VA] 1.5	1.5
Max. switching capacity DC	[W] 9	3
Max. switching capacity DC in mounting kits	[W] 1.5	1.5
Voltage drop	[V] 0 ... 0.5	0 ... 4.5

Output, additional data	
Protection against short circuit	No
Protection against overloading	No

Proximity sensors SME-10M, for C-slot

Technical data – Magnetic reed

Electronic components	
Rated operating voltage [V DC]	24
Operating voltage range AC [V]	5 ... 30
Operating voltage range DC [V]	5 ... 30
Reverse polarity protection	No

Electromechanical components								
Type SME-10M	DS				ZS			
Electrical connection	OE	M8D	M8	M12	OE	M8D	M8	M12
Electrical connection	Cable, 3-wire	Cable with plug, 3-pin			Cable, 2-wire	Cable with plug, 2-pin		
		M8x1 Rotatable thread	M8x1 Snap-on flange	M12x1 Rotatable thread		M8x1 Rotatable thread	M8x1 Snap-on flange	M12x1 Rotatable thread
Connection direction	In-line Lateral							
Cable test conditions	Energy chain: 5 million cycles, bending radius 28 mm							
	Torsional strength: >300,000 cycles, ±270°/0.1 m							
	Resistance to bending: to Festo standard; test conditions on request							
Cable length [m]	0.2 ... 10							
Cable attribute	Energy chain + robot applications							
Cable sheath materials	TPE-U(PU)							

Mechanical components	
Type of mounting	Screw-clamped in slot, insertable from above
Max. tightening torque	0.4
Mounting position	Any
Housing	PA reinforced High-alloy stainless steel

Display/operation	
Switching status display	Yellow LED

Immissions/emissions	
Ambient temperature with flexible cable installation [°C]	-20 ... +70
Protection class	IP65
	IP68

Pin allocation to EN 60947-5-2			
M8x1, 2-pin			
N/O contact			
	Pin	Wire colour	Allocation
	1	Brown	+
	4	Black	Output

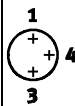
Pin allocation to EN 60947-5-2			
M8x1, 3-pin			
N/O contact			
	Pin	Wire colour	Allocation
	1	Brown	+
	3	Blue	-
	4	Black	Output

Pin allocation to EN 60947-5-2			
M12x1, 2-pin			
N/O contact			
	Pin	Wire colour	Allocation
	1	Brown	+
	4	Black	Output

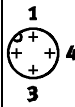
Pin allocation to EN 60947-5-2			
M12x1, 3-pin			
N/O contact			
	Pin	Wire colour	Allocation
	1	Brown	+
	3	Blue	-
	4	Black	Output

Proximity sensors SME-10M, for C-slot

Technical data – Magnetic reed

Dimensions

Download CAD data → www.festo.com

SME-10M-...-L, in-line connection

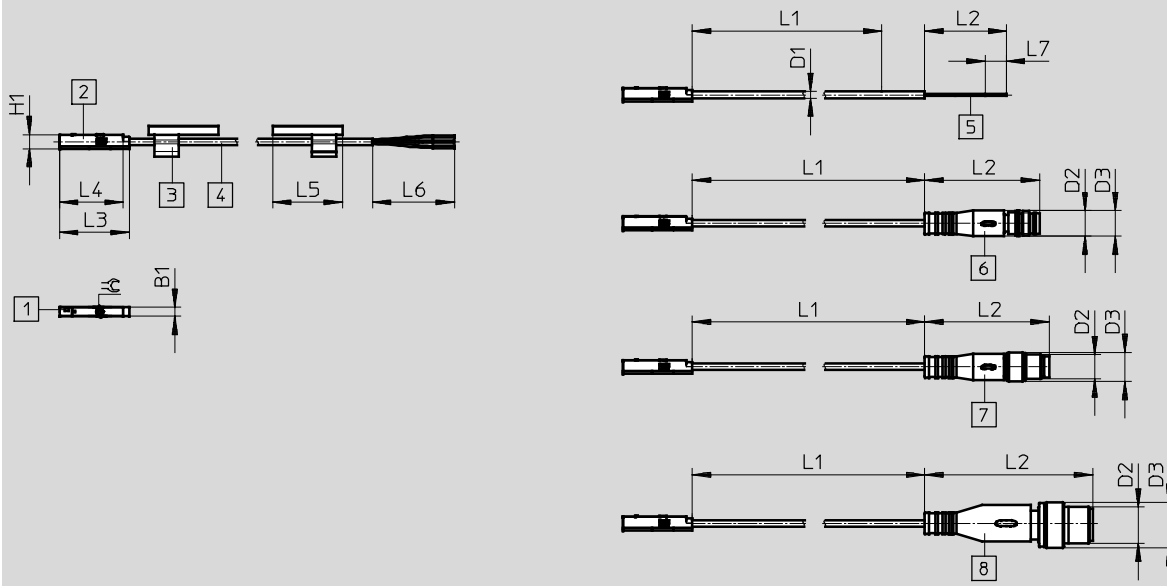

- 1 Yellow LED
- 2 SME-10M
- 3 Inscription label holder
- 4 Connecting cable
- 5 Cable with open end
- 6 Plug M8x1, snap-on flange
- 7 Plug M8x1, rotatable thread
- 8 Plug M12x1
- L1 Cable length

Type	B1	D1	D2	D3	H1	L2	L3	L4	L5	L6	L7	⌀
SME-10M-...-OE	3	2.15	-	-	4.6	50	26.6	24.6	23	50	7	1.5
SME-10M-...-M8D			M8x1	8.5		32.7					-	
SME-10M-...-M8			M8x1	9.6		41.1					-	
SME-10M-...-M12			M12x1	15		55.5					-	

Proximity sensors SME-10M, for C-slot

Technical data – Magnetic reed

Dimensions

Download CAD data → www.festo.com

SME-10M-...-Q, lateral connection

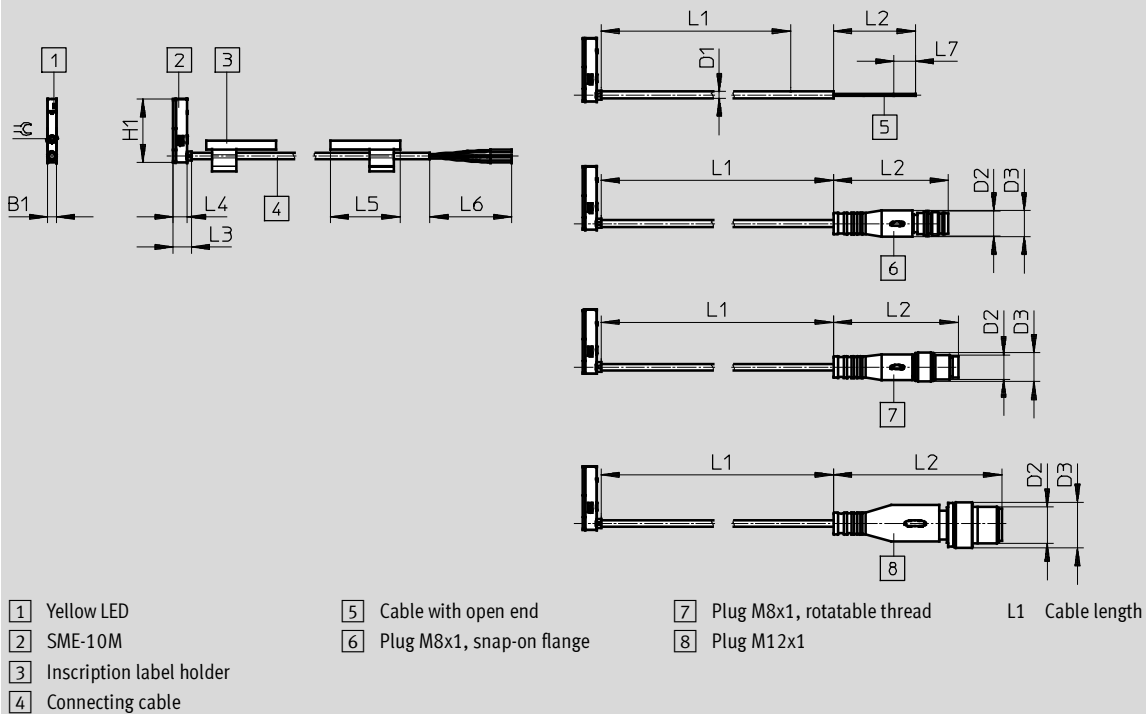

Type	B1	D1	D2	D3	H1	L2	L3	L4	L5	L6	L7	≡
SME-10M-...-OE	3	2.15	-	-	24.6	50	6	4.6	23	50	7	1.5
SME-10M-...-M8D			M8x1	8.5		32.7					-	
SME-10M-...-M8			M8x1	9.6		41.1					-	
SME-10M-...-M12			M12x1	15		55.5					-	

Ordering data

	Switching output	Electrical connection		Cable length [m]	Weight [g]	Part No.	Type	
		Cable	Cable with plug, rotatable thread					
	N/O contact							
	Contacting, bipolar	3-wire	-		2.5	16.8	551365	SME-10M-DS-24V-E-2,5-L-OE
							551366	SME-10M-DS-24V-E-2,5-Q-OE
		-	M8x1, 3-pin		0.3	6.7	551367	SME-10M-DS-24V-E-0,3-L-M8D
							551368	SME-10M-DS-24V-E-0,3-Q-M8D
2-wire	-		2.5	14.6	551369	SME-10M-ZS-24V-E-2,5-L-OE		
					551370	SME-10M-ZS-24V-E-2,5-Q-OE		

Proximity sensors SME-10M, for C-slot

Modular products – Magnetic reed



M Mandatory data							O Options	M
Module No.	Function	Switching output	Rated operating voltage	Cable attribute	Cable length in m	Cable outlet	Cable designation	Connection technology
551364	SME-10M	DS ZS	24V	E	0.2 ... 10	L Q	N	OE M8D M8 M12
Ordering example								
551364	SME-10M	- DS	- 24V	- E	- 3	- L	- N	- M8D

Ordering table				
Size	10	Condi- tions	Code	Enter code
M	Module No.	551364		
	Function	Proximity sensor for C-slot, contacting	SME-10M	SME-10M
			-	-
	Switching output	3-wire N/O contact	DS	
	Switching output	2-wire N/O contact	ZS	
			-	-
	Rated operating voltage [V DC]	24	24V	24V
			-	-
	Cable attribute	Energy chain + robot applications	E	E
			-	-
	Cable length [m]	0.2 ... 10 (0.2 ... 5.0 m in 0.1 m increments, 5.0 ... 10 m in 0.5 m increments)	...	
			-	-
	Cable outlet	In-line	L	
		Lateral	Q	
			-	-
O	Cable designation	With inscription label holder	-	
		Without inscription label holder	N	
M			-	-
	Connection technology	Open end	OE	
		M8, rotatable thread	M8D	
		M8, snap-on flange	M8	
		M12, rotatable thread	M12	

Transfer order code

551364	SME-10M	-		-	24V	-	E	-		-		-		-	
--------	---------	---	--	---	-----	---	---	---	--	---	--	---	--	---	--

Proximity sensors SME-10, for C-slot

Type codes

SME-10	
SME – 10 – KL – LED – 24	
Function	
SME	Proximity sensor, magnetic reed
Design	
10	For C-slot, insertable in slot lengthwise
Electrical connection, cable length, connection direction	
KL	Cable, 2.5 m, in-line
KQ	Cable, 2.5 m, lateral
SL	Plug M8x1 with cable, 0.3 m, in-line
SQ	Plug M8x1 with cable, 0.3 m, lateral
Switching status display	
LED	Yellow LED
Rated operating voltage	
24	24 V DC

Proximity sensors SME-10, for C-slot

Technical data – Magnetic reed

Function

NO contact, 3-wire, with cable

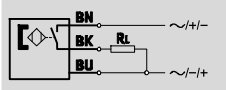

N/O contact, 3-wire, with plug

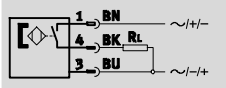

- Magneto-resistive measuring principle
- Insertable in the slot lengthwise

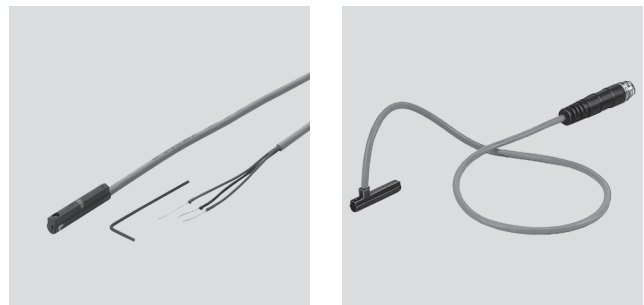

General technical data	
Design	For C-slot
Based on standard	EN 60947-5-2
CE mark (see declaration of conformity)	To EU EMC Directive
Note on materials	Free of copper and PTFE

Input signal/measuring element	
Measuring principle	Magnetic reed
Ambient temperature [°C]	-20 ... +70

Switching output	
Switching output	Contacting, bipolar
Switching element function	N/O contact
Reproducibility of switching value [mm]	±0.1
Switch-on time [ms]	≤0.6
Switch-off time [ms]	≤0.05
Max. output current [mA]	100
Max. switching frequency [Hz]	500
Max. switching capacity DC [W]	1
Voltage drop [V]	0

Output, additional data	
Protection against short circuit	No
Protection against overloading	No

Electronic components	
Operating voltage range DC [V]	12 ... 27
Operating voltage range AC [V]	12 ... 27
Reverse polarity protection	No

Electromechanical components		
Type	SME-10-...-K...-...	SME-10-...-S...-...
Electrical connection	Cable, 3-wire	Cable with plug M8x1, 3-pin
Connection direction	In-line, lateral	In-line, lateral
Cable length [m]	2.5	0.3
Information on cable sheath materials	PUR	

Proximity sensors SME-10, for C-slot

Technical data – Magnetic reed

Mechanical components		
Type	SME-10-...-K...-...	SME-10-...-S...-...
Type of mounting	Clamped in C-slot, insertable in the slot lengthwise	
Tightening torque	[Nm]	0.18
Information on housing materials	PPS, high-alloy stainless steel	PPS, TPE-U(PU), high-alloy stainless steel, nickel-plated brass

Display/operation	
Switching status display	Yellow LED

Immissions/emissions		
Ambient temperature with flexible cable installation	[°C]	-5 ... +70
Protection class		IP65
		IP67
Insulation voltage	[V]	50
Surge capacity	[kV]	0.8
Degree of contamination		3

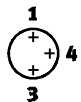
Pin allocation to EN 60947-5-2			
Plug, 3-pin			
M8x1	Pin	Wire colour	Allocation
	1	Brown	+
	3	Blue	-
	4	Black	Output

Proximity sensors SME-10, for C-slot

Technical data – Magnetic reed

FESTO

Dimensions Download CAD data → www.festo.com

Cable, in-line connection **Cable, lateral connection**

- 1 Connecting cable
- 2 Theoretical switching point
- 3 Threaded pin M2x4
- 4 Yellow LED (positive switching)
- 5 Yellow LED (negative switching)

Plug M8x1, in-line connection

- 1 Plug to fit connecting cable NEBU-M8
- 2 Theoretical switching point
- 3 Threaded pin M2x4
- 4 Yellow LED (positive switching)
- 5 Yellow LED (negative switching)

Plug M8x1, lateral connection

- 1 Plug to fit connecting cable NEBU-M8
- 2 Theoretical switching point
- 3 Threaded pin M2x4
- 4 Yellow LED (positive switching)
- 5 Yellow LED (negative switching)

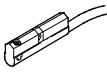
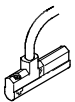
Ordering data						
	Switching output	Electrical connection		Cable length [m]	Part No.	Type
		Cable	Cable with plug, M8x1			
In-line connection						
	N/O contact					
	Contacting, bipolar	3-wire	–	2.5	173210	SME-10-KL-LED-24
–		3-pin	0.3	173212	SME-10-SL-LED-24	
Lateral connection						
	N/O contact					
	Contacting, bipolar	3-wire	–	2.5	173211	SME-10-KQ-LED-24
–		3-pin	0.3	173213	SME-10-SQ-LED-24	

Proximity sensors SMT-10G, for C-slot

Type codes

SMT-10G

		SMT	10G	PS	24V	E	2,5Q	OE
Function								
SMT	Proximity sensor, magneto-resistive							
Design								
10G	For C-slot, insertable in slot lengthwise							
Switching output, switching element function								
PS	PNP, N/O contact, 3-wire							
Rated operating voltage								
24V	24 V DC							
Cable properties								
E	Energy chain + robot applications							
Cable length [m], connection direction								
2,5Q	Cable, 2.5 m, lateral ¹⁾							
0,3Q	Cable with plug, 0.3 m, lateral ²⁾							
Electrical connection								
OE	Open end							
M8D	Cable with plug M8x1, rotatable thread							

1) Only with electrical connection OE

2) Not with electrical connection OE

Proximity sensors SMT-10G, for C-slot

Technical data – Magneto-resistive



Function

PNP, N/O contact, with cable, 3-wire

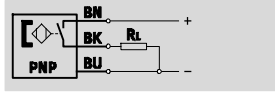

- Magneto-resistive measuring principle
- Insertable in slot lengthwise
- Design ideally matched to gripper sensing

PNP, N/O contact, with plug

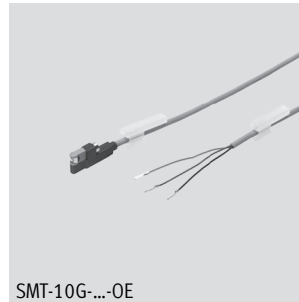
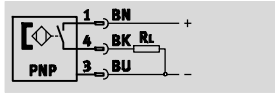

General technical data	
Design	For C-slot
Based on standard	EN 60947-5-2
Certification	c UL us - Listed (OL)
CE mark (see declaration of conformity)	To EU EMC Directive
Note on materials	Free of copper and PTFE RoHS-compliant

Input signal/measuring element	
Measuring principle	Magneto-resistive
Ambient temperature [°C]	-20 ... +70

Switching output	
Switching output	PNP
Switching element function	N/O contact
Max. output current [mA]	80
Max. switching capacity DC [W]	2.4

Output, additional data	
Protection against short circuit	Pulsed
Protection against overloading	Yes

Electronic components	
Operating voltage range [V DC]	10 ... 30
Reverse polarity protection	For all electrical connections

Electromechanical components		
Type	SMT-10G-...-OE	SMT-10G-...-M8D
Electrical connection	Cable, 3-wire	Cable with plug M8x1, 3-pin, rotatable thread
Connection direction	Lateral	
Cable test conditions	Energy chain: 5 million cycles, bending radius 28 mm Torsional strength: > 300,000 cycles, ±270°/0.1 m Resistance to bending: to Festo standard; test conditions on request	
Cable length [m]	2.5	0.3
Cable properties	Energy chain + robot applications	
Cable sheath material	Thermoplastic polyurethane elastomer	

Mechanical components	
Type of mounting	Clamped in C-slot Insertable in slot lengthwise
Housing material	Reinforced polyamide

Proximity sensors SMT-10G, for C-slot

Technical data – Magneto-resistive



Display/operation	
Switching status display	Yellow LED

Immissions/emissions	
Ambient temperature with flexible cable installation	[-5 ... +70] °C
Protection class	IP65
	IP68

Pin allocation to EN 60947-5-2			
PS			
Plug, 3-pin			
M8x1	Pin	Wire colour	Allocation
	1	Brown	+
	3	Blue	-
	4	Black	Output

Dimensions Download CAD data → www.festo.com

1 LED 3 Holder for inscription label 4 Connecting cable
 2 SMT-10G 5 Plug M8x1

	D1	D2	D3	B1	B2	B3	B4	H1	H2	L1	L2	L3	L4	L5	L6	L7	⌀
SMT-10G-...-OE	2.9	-	-	5.4	5	3.75	3	10	5	2500 +70	25	-	14.4	23	50	2.75	1.5
SMT-10G-...-M5D		M5x0.5	6							300 +30							

Ordering data						
	Switching output	Electrical connection		Cable length [m]	Part No.	Type
		Cable	Cable with plug, rotatable thread, M8x1			
N/O contact						
	PNP	3-wire	-	2.5	547862	SMT-10G-PS-24V-E-2,5Q-OE
		-	3-pin	-	0.3	547863

Proximity sensors SMT/SME-10, for C-slot

Accessories



Mounting SMBN-10

for mounting proximity sensors
SME/SMT-10 on drives with T-slot

Materials:

Rail: Anodised wrought aluminium alloy

Screws: High-alloy stainless steel

Note on materials:

Free of copper and PTFE

RoHS-compliant

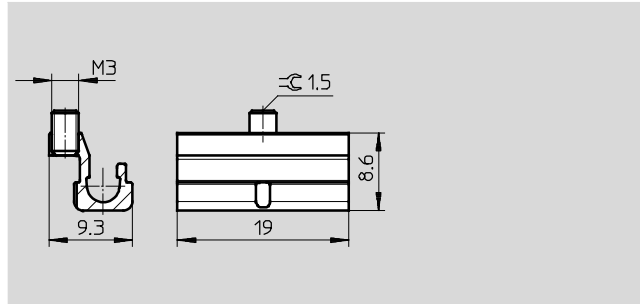
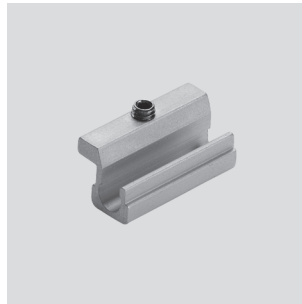

Ordering data

For piston Ø	Part No.	Type
125 ... 320	537809	SMBN-10

Mounting kit SMBR

Material:

Polyacetal

RoHS-compliant

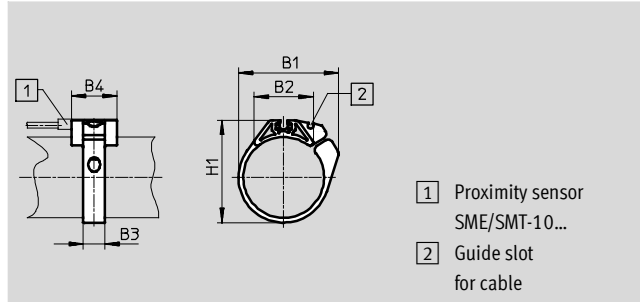

- 1 Proximity sensor
SME/SMT-10...
- 2 Guide slot
for cable

Dimensions and ordering data

For piston Ø	B1	B2	B3 ±0.1	B4 ±0.1	H1	Part No.	Type
6	15.6	9.4	7	19	13.5	173226	SMBR-10-6
8	18.9	12.3	7	19	17.5	175101	SMBR-10-8
10	20.4	13.7	7	19	19.9	173227	SMBR-10-10
12	22.7	14.3	7	19	21.9	175102	SMBR-10-12
16	26.1	17	7	19	25.7	173228	SMBR-10-16
20	33.2	20.8	9	19	30.4	175103	SMBR-10-20
25	36.5	22.6	9	19	35.6	175104	SMBR-10-25
32	41.7	24.5	9	19	42.7	175105	SMBR-10-32
40	47	26.5	9	19	50.7	175106	SMBR-10-40
50	56.4	28.6	9	19	61.5	175107	SMBR-10-50
63	69.4	32	9	19	74.5	175108	SMBR-10-63

Proximity sensors SMT/SME-10, for C-slot

Accessories

Positioning component SMM

Insertable in slot lengthwise

Ambient temperature: -40 ... +120 °C

Materials:

Housing: Anodised wrought aluminium alloy

Screws: High-alloy stainless steel

Note on materials:

RoHS-compliant

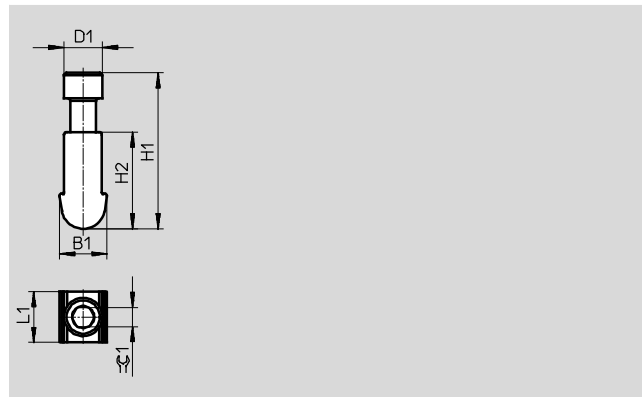

Dimensions and ordering data									
B1	D1	H1	H2	L1	∅1	CRC ¹⁾	Part No.	Type	PU ²⁾
3.75	3.0	12.23	7.6	4.0	1.5	3	547942	SMM-10	10

1) Corrosion resistance class 4 according to Festo standard 940 070

Components subject to particularly high corrosion stress. Parts used with aggressive media, e.g. in the food or chemical industry. These applications should be supported with special tests with the media if required.

2) Packaging unit

Ordering data – Connecting cables						Technical data → Internet: nebu	
Type	Number of wires	Cable length [m]	Part No.	Type			
Socket M8x1, 3-pin							
	For SMT/SME-10...	3	2.5	541333	NEBU-M8G3-K-2.5-LE3		
			5	541334	NEBU-M8G3-K-5-LE3		
	For SMT/SME-10...	3	2.5	541338	NEBU-M8W3-K-2.5-LE3		
			5	541341	NEBU-M8W3-K-5-LE3		

Ordering data – Mounting attachments			
For ∅	Part No.	Type	
	6	173205	WSM-6-SME-10
	8	173206	WSM-8-SME-10
	10	173207	WSM-10-SME-10
	-	534255	SMBK-10

Ordering data – Inscription labels, safety clips				
Size	Part No.	Type	PU ¹⁾	
	23x4 mm	541598	ASLR-L-423	34
	M8	548067	NEAU-M8-GD	1
	M12	548068	NEAU-M12-GD	1

1) Packaging unit per frame

Ordering data – Sensor tester		
Part No.	Type	
	158481	SM-TEST-1